

Vena II

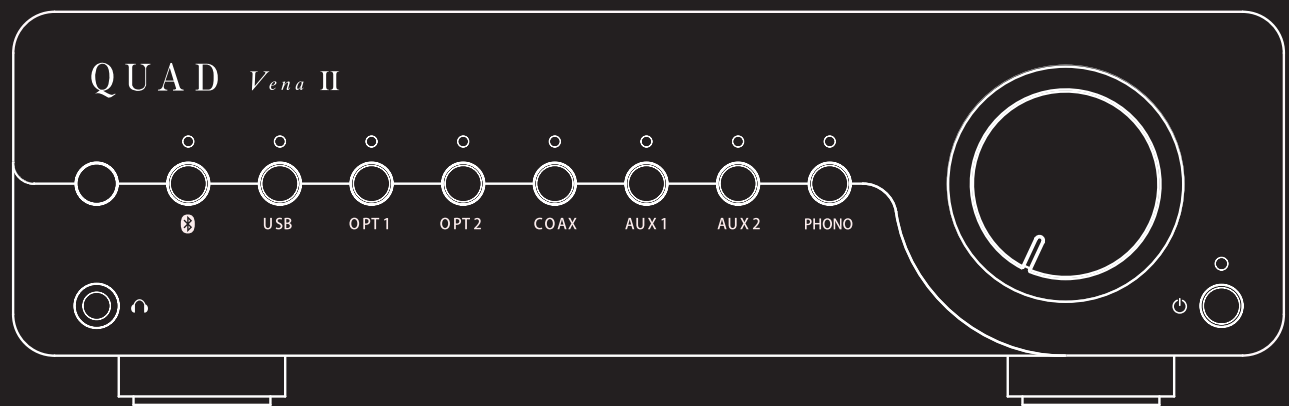

Integrated Amplifier

User Manual

QUAD *the closest approach to the original sound*

IMPORTANT SAFETY INFORMATION



This lightning flash with arrowhead symbol within an equilateral triangle is intended to alert the user to the presence of non-insulated "dangerous voltage" within the product's enclosure that may be of sufficient magnitude to constitute a risk of electric shock.

Warning: To reduce the risk of electric shock, do not remove the cover (or back) as there are no user-serviceable parts inside. Refer servicing to qualified personnel.

This exclamation point within an equilateral triangle is intended to alert the user to the presence of important operating and maintenance instructions in the literature accompanying the appliance.

Read these instructions.

Keep these instructions.

Heed all warnings.

Follow all instructions.

Do not use this apparatus near water.

Clean only with dry cloth.

Do not block any ventilation openings. Install in accordance with the manufacturer's instructions.

Do not install near any heat sources such as radiators, heat registers, stoves, or other apparatus (including amplifiers) that produce heat.

Do not defeat the safety purpose of the polarized or grounding plug. A grounding plug has two blades and a third grounding prong. The wide blade or the third prong is provided for your safety. If the provided plug does not fit into your outlet, consult an electrician for replacement of the obsolete outlet.

Protect the power cord from being walked on or pinched particularly at the plugs, convenience receptacles, and at the point where they exit from the apparatus.



Use only with the cart, stand, tripod, bracket, or table specified by the manufacturer, or sold with the apparatus. When a cart or rack is used, use caution when moving the cart/apparatus combination to avoid injury from

tip-over.

Unplug this apparatus during lightning storms or when unused for long periods of time.

Refer all servicing to qualified service personnel. Servicing is required when the apparatus has been damaged in any way, such as power supply cord or plug is damaged, liquid has been spilled or objects have fallen into the apparatus, the apparatus has been exposed to rain or moisture, does not operate normally, or has been dropped.

WARNING: Only use attachments/accessories specified or provided by the manufacturer (such as the recommended battery - not supplied).

WARNING: The mains plug/appliance coupler/is used as disconnection device; the disconnection device shall remain readily operable.

CAUTION: These servicing instructions are for use by qualified service personnel only. To reduce the risk of electric shock, do not perform any servicing other than that contained in the operating instructions unless you are qualified to do so.

Do not install this equipment in a confined or built-in space such as a bookcase or similar unit, and keep well ventilated in open space. The ventilation should not be impeded by covering the ventilation openings with items such as newspaper, table-cloths, curtains etc.

WARNING: To reduce the risk of fire or electric shock, do not expose this apparatus to rain or moisture. The apparatus shall not be exposed to dripping or splashing and ensure that objects filled with liquids, such as vases, shall not be placed on the apparatus. No naked flame sources, such as lighted candles, should be placed on the apparatus.

WARNING: Do not ingest the battery, Chemical Burn Hazard. This product requires a coin/button cell battery (not included). If the coin/button cell battery is swallowed, it can cause severe internal burns in just 2 hours and can lead to death. Keep new and used batteries away from children. If the battery compartment does not close securely, stop using the product and keep it away from children. If you think batteries might have been swallowed or placed inside any part of the body, seek immediate medical attention.



Ground protection terminal. This product should be connected to a power outlet with ground protection.

Denmark: Apparatusets stikprop skal tilsluttes en stikkontakt med jord, som giver forbindelse til stikproppens jord.

Finland: Laite on liitettävä suojakoskettimilla varustettuun pistorasiaan.

Norway: Apparatet må tilkoples jordet stikkontakt.

Sweden: Apparaten skall anslutas till jordat uttag.



This product will generate certain heat during use. Please pay attention to the hot surface.

WARNING: No naked flame sources, such as lighted candles, should be placed on the apparatus.

WARNING: Attention should be drawn to environmental aspects of battery disposal.

WARNING: Use of the apparatus in tropical climates.



QUAD

Vena II

CONTENTS

INTRODUCTION	4
UNPACKING THE EQUIPMENT.....	4
USB DRIVERS (AND FIRMWARE UPDATES)	4
PLACEMENT	4
CONTROLS AND FUNCTIONS	5
OUTPUT CONNECTIONS	7
INPUT CONNECTIONS	9
REMOTE HANDSET	10
OPERATION	11
SPECIFICATIONS	13
CARE AND CLEANING	14



The Bluetooth® word mark and logos are registered trademarks, owned by Bluetooth SIG, Inc. and any use of such marks by IAG Group Ltd is under license. Other trademarks and trade names are those of their respective owners.



aptX® software is copyright CSR plc. or its group companies. All rights reserved.

The aptX® mark and the aptX logo are trademarks of CSR plc. or one of its group companies and may be registered in one or more jurisdictions.

INTRODUCTION

Thank you for your investment in the QUAD Vena II. We are sure that the Vena II will continue to delight you for years to come.

The QUAD Vena II is designed to be the perfect match to a wide variety of sources and provides the necessary amplification to realise the highest quality of your stored music replaced through your loudspeakers and headphones.

You can link the Vena II to both analogue and digital sources, thanks to its diversity of inputs. You can also stream music to Vena II from any Bluetooth® device such as portable music players and smartphones. QUAD Vena II is designed with the innovative aptX. codec built in so that you can hear CD quality audio over the Bluetooth wireless connection.

Please read this manual carefully to discover all the ways you can connect your equipment to the QUAD Vena II and learn how to get the best performance from all of your music sources.

UNPACKING THE EQUIPMENT

The carton contains:

- The QUAD Vena II
- One IEC mains cable with a plug suitable for your area
- One remote handset
- One antenna (for metal enclosure version only. Vena II with wooden chassis does not have antenna)
- User manual

Please note: The remote control requires 1 x CR2025 type battery. Due to international shipping and courier regulations with Lithium Ion batteries, the remote controller battery is not included in this package.

Consult the dealer from whom you purchased the equipment if any item is not present. Carefully unpack the unit and accessories, so as not to damage the surface finish. Retain the packing materials for future use. Retain the user manual and information concerning the date and place of purchase of your equipment for future reference. If you transfer any unit to a third party please pass on this instruction manual along with the equipment.

USB DRIVERS (AND FIRMWARE UPDATES)

To download Windows Drivers, please see the separate manual. Any firmware updates will also be available from www.quad-hifi.co.uk

PLACEMENT

The unit must be mounted on a solid, level and stable surface. Before you connect the QUAD Vena II to AC mains power, ensure your AC mains voltage corresponds to the rating on the rear panel of the product. If in doubt, consult your dealer. If you move to an area which has a different mains voltage, seek advice from a QUAD appointed dealer or a competent service technician.

CONTROLS AND FUNCTIONS

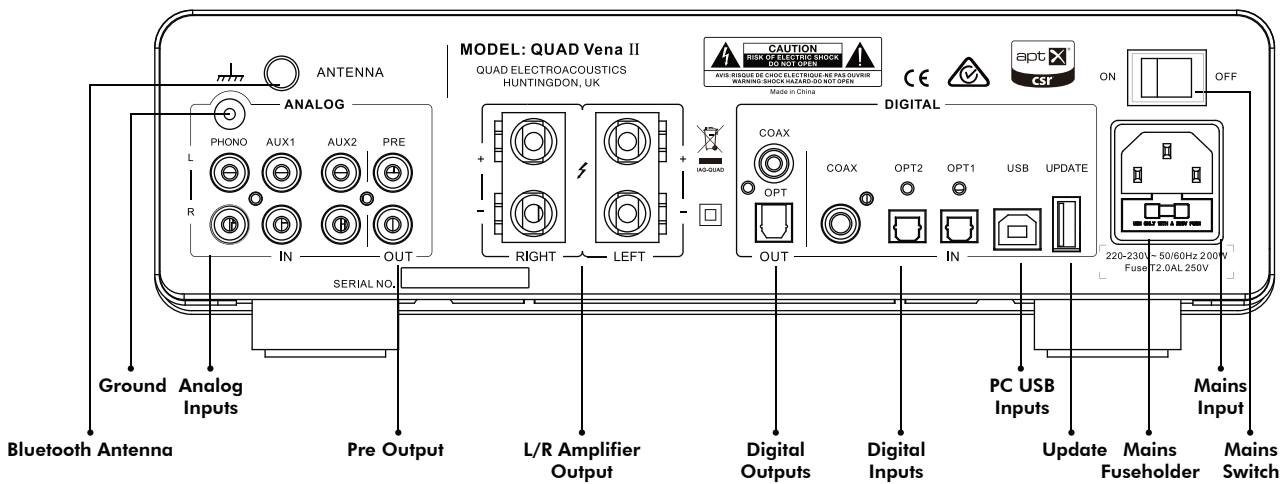
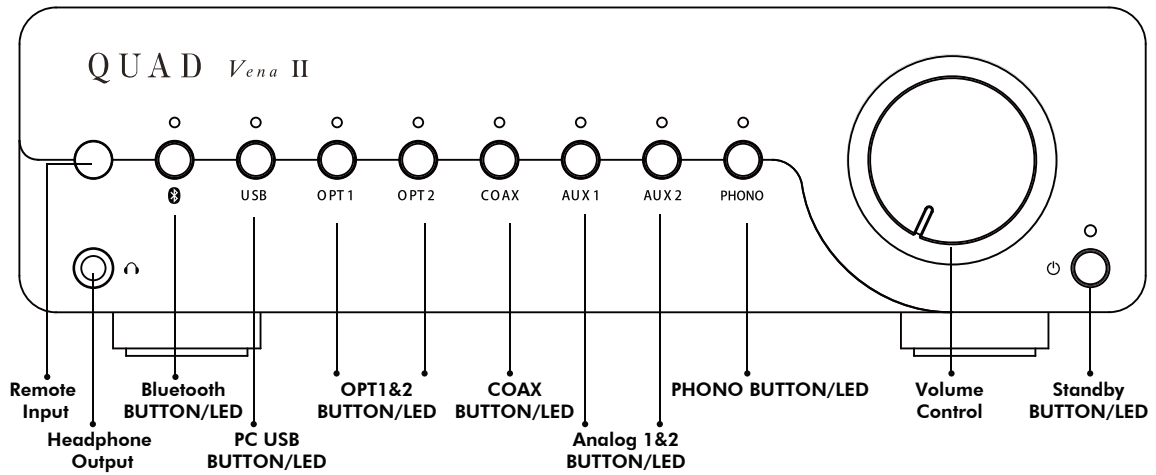

* Vena II with wooden chassis does not require Bluetooth antenna

INSTALLATION

Before making any connections to your high fidelity equipment make sure that all units in the system are switched off and unplugged at the mains.

Mains Connections

The Mains On/Off switch is on the rear panel. Before connecting your QUAD equipment to the AC mains supply check and make sure the voltage marked on the back matches your supply voltage.

Digital Signal Output Connections

Coaxial Output

Vena II has one coaxial SPDIF output. Connect an RCA digital interconnect between the digital coaxial out of Vena II unit and the required input of your equipment.

Optical Outputs

Vena II has one optical SPDIF output. Connect an optical (TOSLink) interconnect between the digital optical out of Vena II and the required input of your equipment.

Analog Signal Output Connections

Preamplifier Output

Vena II has one pair of unbalanced RCA outputs which can make Vena II operate as a preamplifier.

Connect an RCA cable between the unbalanced pre output of Vena II and the unbalanced input of a power amplifier or associated equipment. Interconnection should be of low-noise construction and fully screened to minimize hum and noise transmission.

Loudspeaker Outputs

Vena II has two sets of loudspeaker outputs. They are independent for right and left stereo amplifier outputs.

Connect the Positive (+) RED terminals of the amplifier to the Positive (+) RED terminals of the loudspeakers. Connect the Negative (-) BLACK terminals similarly. When connecting loudspeakers tighten the terminals securely by hand. Make sure there are no loose strands of wires which could cause short circuits.

Headphone Output

Vena II has a stereo 6.3mm(1/4") jack on the front panel for connecting headphones. Connecting headphones mutes the audio signal to the loudspeakers. Vena II headphone output can be set up to 4.5V, users can select suitable output levels to suit their headphones.

WARNING: Listening to music at high volume levels and for extended durations can damage one's hearing. In order to reduce the risk of damage to hearing, one should lower the volume to a safe, comfortable level, and reduce the amount of time listening at high levels. Headsets should comply with EN 50332-2 requirements (for GS certification).

OUTPUT CONNECTIONS

Artera Play

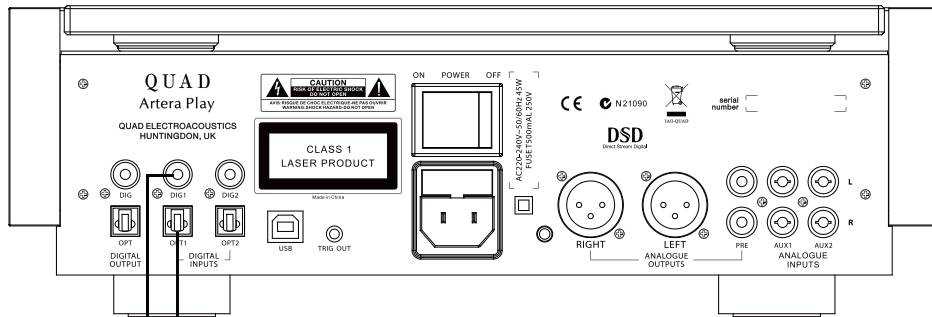

Loudspeaker Right

Loudspeaker Left

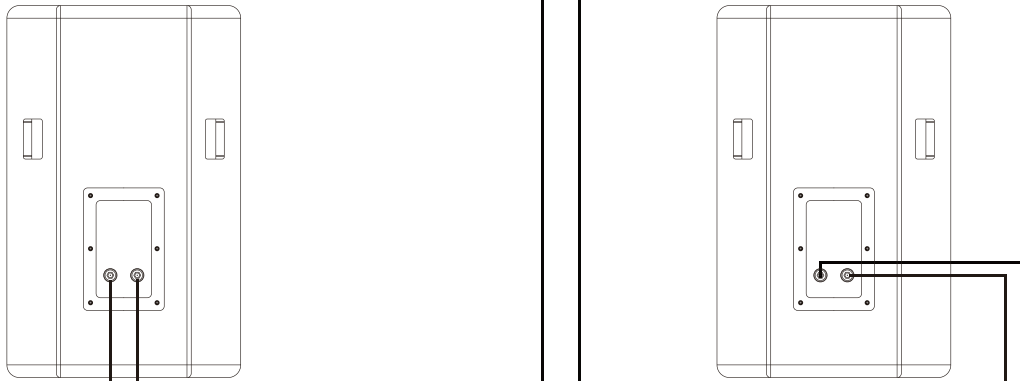

QUAD Vena II

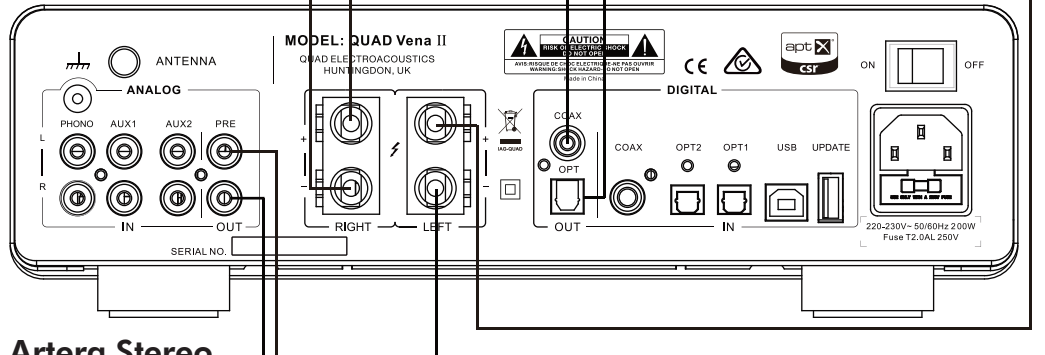

Artera Stereo

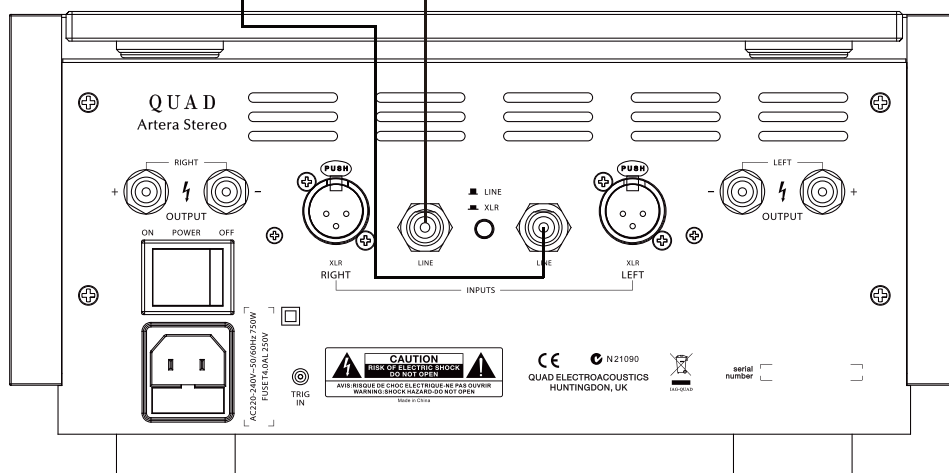

Analog Signal Input Connections

Vena II has two sets of unbalanced RCA inputs for connection to units which do not feature balanced outputs. Both sets are identical.

Connect an RCA cable between the unbalanced input of Vena II and the unbalanced output of a source unit like a CD player or DAC. Interconnections should be of low-noise construction and fully screened to minimize hum and noise transmission.

PHONO Signal Input Connections

Vena II has a PHONO signal input, the PHONO input should only be connected to turntables fitted with MM or high output MC cartridges.

Digital Signal Input Connections

Vena II has a variety of digital inputs, which can be connected to most popular digital sources, like the digital output of a CD or DVD player, DAC, PC.

Coaxial Inputs

Vena II has a coaxial SPDIF input. Connect an RCA digital interconnect between the digital coaxial output of the source unit to the COAX input of Vena II.

Optical Inputs

Vena II has an optical SPDIF input. Connect an optical (TOSlink) interconnection between the digital optical output of the source unit to the OPT1 or OPT2 input on Vena II.

Bluetooth Input

Vena II has a built-in Bluetooth signal processor module which can play audio files transmitted from the source unit via Bluetooth wireless transmission. Please refer to page 12 to enable this function.

USB Input

Vena II has one B-type USB input which lets you connect a Mac or PC to play audio files stored on a computer.



B-type USB

INPUT CONNECTIONS

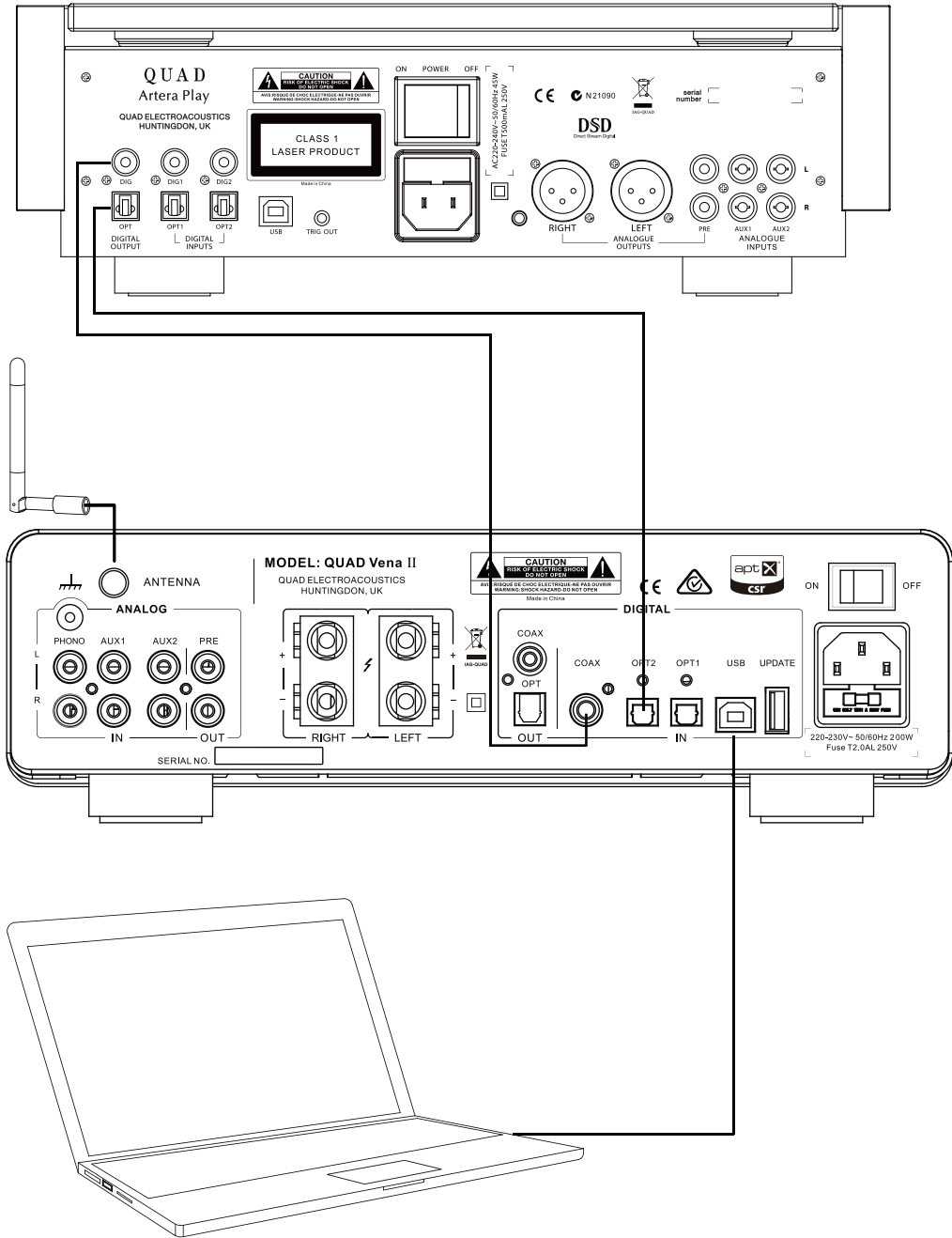

REMOTE HANDSET

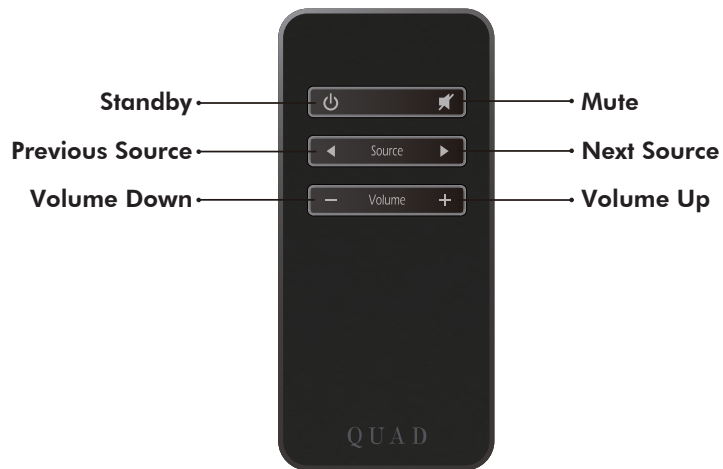

Press to bring product in/out of Standby mode



Press to Mute/Unmute the sound. In Mute , the volume indicator on the front panel will flash



Press to select Previous Source



Press to select Next Source



Press to increase volume



Press to decrease volume

Remote Controller Preparation

- Unpack the handset
- Invert the handset
- Remove the battery cover
- Insert a new battery (type CR2025, not supplied)
- Close the battery cover

Caution



To prevent any burning, fire, or any possible harm to the environment or human health from the depleted batteries, please correctly dispose of the waste batteries in light of the recycling rules in your area. Don't dismantle, crush or puncture the batteries. Never short-circuit the batteries, throw the batteries into the water or fire or even try to repair them. The battery only can be changed with CR2025.

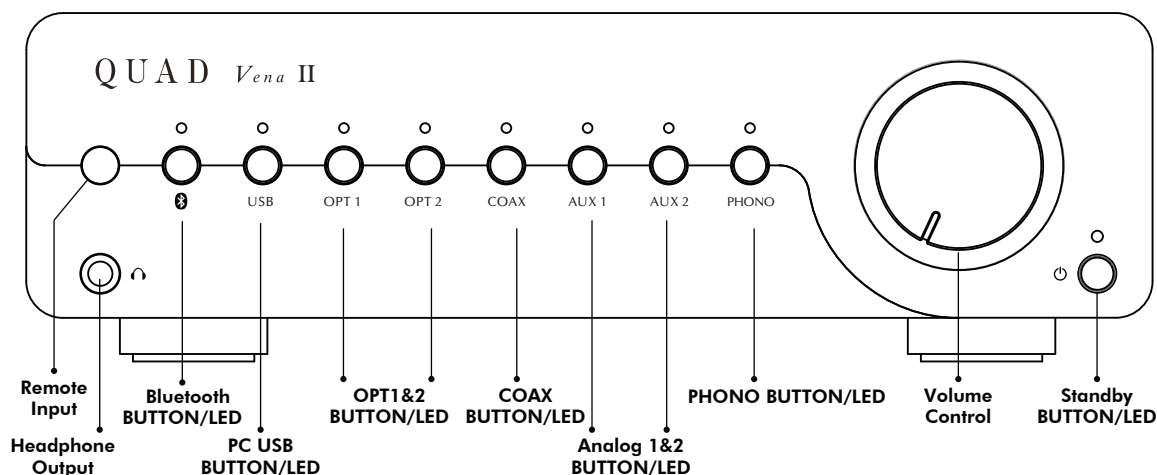

OPERATION



Standby Mode

Vena II will be in standby mode when powered on. The  indicator on front panel is lit. Press  button to bring Vena II out of standby.

You can activate the 'auto standby' function by holding the  button down for 3 seconds.

Using this 'auto standby' function, Vena II will automatically go into standby mode when there is no signal input or operation for 30 minutes. Vena II will be switched to the Bluetooth source input when unit is activated for the first time, and switched to the last input source used after that.

Protection Mode

Vena II is protected by a thermal switch which interrupts the AC Power supply if the amplifier is grossly overloaded for a period of time. To restore operation, simply press the  button on the front panel. It is thus fully protected against gross overload, short-circuited output etc, but not necessarily against seriously inadequate ventilation.

Mute Mode

Vena II will go into Mute mode with no sound output for 3 seconds when the unit is switched on and all indicators will flash 3 times. After 3 seconds the indicators will stop flashing and Vena II will exit from Mute mode.

Users can also press  to bring Vena II in or out of Mute mode when playing music.

Combination Keys Function

Vena II has a volume control knob on the front panel. Users can decrease or increase the music level with this volume knob. Please always turn up the volume gradually.

Playing Music via Analog Inputs

Connect the analog signal of a source unit to Vena's AUX1 or AUX2 input. Press AUX1 or AUX2 button on the front panel. AUX1 or AUX2 indicator will be lit and music will start playing.

Playing Music via Digital Inputs

Connect coaxial SPDIF signal of source units to the digital in COAX jack on Vena's rear panel. Press COAX button on the front panel, COAX indicator will be lit and music will start playing.

Connect optical (TOSLink) signal of source units to Vena's OPT1 or OPT2 jack on Vena's rear panel. Press OPT1 or OPT2 button on the front panel. OPT1 or OPT2 indicator will be lit and music will start playing.

Playing Music via USB input

Connect a Mac or PC via the B-type USB interface on Vena's rear panel. Press USB button on the front panel. USB indicator will be lit, and then click Play on your music player software to play audio files stored on your computer.

Playing Music via Bluetooth

You can wirelessly connect Vena II to a music source via Bluetooth wireless technology. Volume up/down, standby and mute in/out can be controlled from either your Bluetooth source or from Vena II. Other functions-play, pause, previous track, next track, fast forward and reverse are all controlled from your Bluetooth source only.

Establishing a Bluetooth Connection

1. Place Vena II and a Bluetooth music source within a few meters of each other.
2. Power on Vena II and select Bluetooth as the source. The Bluetooth source indicator will flash when in pairing mode.
3. Activate the Bluetooth function on your music source.
4. Select "Quad Vena II" when Vena II is found to start the pairing process.
5. If prompted for a password, enter "0000".

To play music

Select Vena II as a music output device on your Bluetooth source to start playing music.

Disconnecting Bluetooth Connection

To disconnect the Bluetooth music source either:

- Move the Bluetooth source beyond the communication area
- Turn off the connected device or turn off its Bluetooth function

Note:

If you have difficulty connecting Vena II to a Bluetooth device, please try selecting "Forget this Device" on your source unit and then go through the connection procedure again.

SPECIFICATIONS

(All measurement made with 230V supply)

Model	Vena II
D/A Converter	ESS Sabre32 Reference ES9018K2M
Input Sampling Rates	Optical, Coaxial:44.1kHz---192kHz; USB:44.1kHz---384kHz (PCM) / DSD64, DSD128, DSD256
Rated Output Power	2 x 45W (8ohm) / 2 x 65W (4ohm)
Total Harmonic Distortion	<0.005% (30W, 8ohm)
Frequency Response	20Hz-20KHz (+/- 0.5dB)
Input Sensitivity	450mV (RCA AUX IN); 4.1mV (PHONE MM)
Input Impedance	10Kohm (AUX); 47Kohm // 100pF (Phono)
Signal to Noise Ratio (S/N)	≥108dB (A Weighted, ref. 45W)
Pre Output Level	2.3V (Max)
Pre Output Total Harmonic Distortion (THD)	<0.002%
Pre Output Signal to Noise (S/N)	>110dB (A-Weighted)
Bluetooth Version	4.0
Profile	A2DP
Codec	aptX (priority), SBC
USB Input	1 x USB (B-type)
USB Input Sampling Rates	44.1kHz---384kHz (PCM)/DSD64, DSD128, DSD256
Digital Audio Inputs	2 x Optical TOSlink 1 x RCA Coax
Digital Audio Outputs	1 x Optical TOSlink 1 x RCA Coax
Analog Inputs	2 x RCA (AUX1 AUX2); 1 x RCA (PHONE MM)
Power Requirement	220-230V~50/60Hz 110-120V~50/60Hz 100V 50/60Hz
Dimensions (W x H x D)	313 x 93.5 x 302 (mm)
Metal Enclosure	6.1kg
Wood Cabinet	7.5kg

Care And Cleaning

While cleaning is in progress the AC power cord must be unplugged from the AC power supply socket.

The surface of the equipment should be cleaned with a damp soft cloth. Solvent based cleaning materials should not be used as they may damage the finish.

If you have any queries regarding the use of QUAD equipment, consult your dealer.

Warranty

QUAD equipment is guaranteed against any defect in material and workmanship for a period of one year from the date of purchase. Proof of purchase is required for warranty claims.

Please complete and return the enclosed Warranty Registration Form. Within the warranty period QUAD will undertake replacement of defective parts free of charge provided that the failure was not caused by misuse, accident or negligence. Your statutory rights within the territory in which you purchased the equipment is not affected by this warranty.

QUAD carries out regular reviews and reserves the right to adjust the specifications and performance from time to time.

Servicing

Product service enquiries should, in the first instance, be referred to the supplying dealer. If you need to return your equipment for servicing we recommend that it is shipped in its original packing.

In cases of difficulty or for other product enquiries please contact that appointed QUAD distributor for your country. Principal Service Centre addresses and contact numbers can be found below.

For information of worldwide authorized service centres, please read worldwide distributor list on the QUAD website: www.quad-hifi.co.uk.

International Service Centre Address

IAG House, 13/14 Glebe Road, Huntingdon, Cambridgeshire, PE 29 7DL, UK

Tel: +44 (0) 1480 452561 Eml: service@quad-hifi.co.uk



Correct Disposal of this product. This marking indicates that this product should not be disposed with other household wastes throughout the EU. To prevent possible harm to the environment or human health from uncontrolled waste disposal, recycle it responsibly to promote the sustainable reuse of material resources. To return your used device, please use the return and collection systems or contact the retailer where the product was purchased. They can take this product for environmental safe recycling.

QUAD

IAG House, 13/14 Glebe Road, Huntingdon, Cambridgeshire, PE29 7DL, UK
Tel: +44(0)1480 452561 Eml: service@quad-hifi.co.uk <http://www.quad-hifi.co.uk>
IAG reserves the right to alter the design and specifications without notice. All rights reserved © IAG Group Ltd.
QUAD is a member of the International Audio Group.